

**EXPLANATION OF METALIC CONTACT IN HYDRAULIC
CYLINDERS**

Jan Spoormaker

Spoormaker Consultancy

[www. Spoormaker-Consultancy.com](http://www.Spoormaker-Consultancy.com)

ANTEC 2005

Containerized Ring Cranes



Lifting capacity	1600 mT
Own weight	600 mT
Maximum ballast	1500 mT
Length main mast	97 m
Height approximate	165 m

Spoomaker Consultancy in Reliability & Liability of Plastic Products

Leveling of the crane

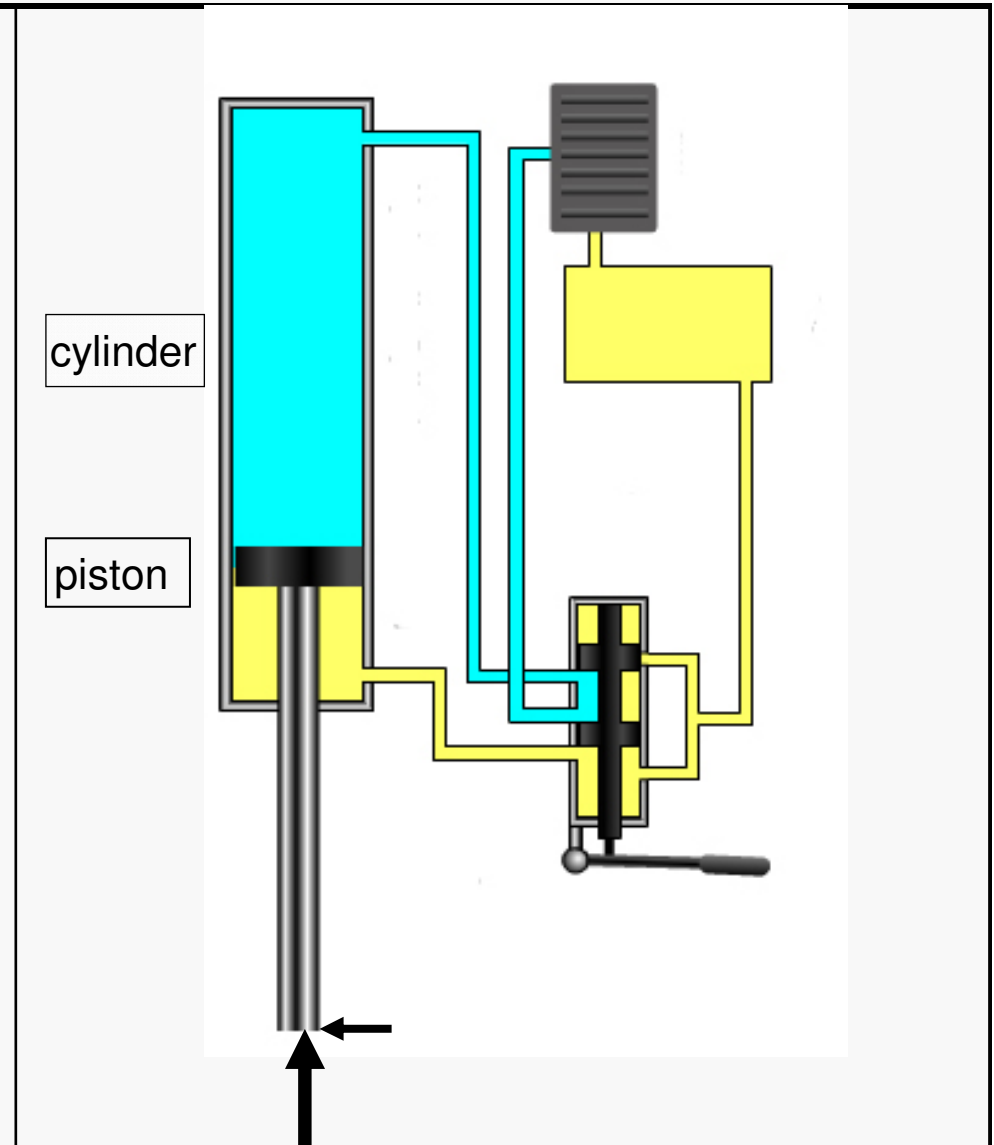

wear rings

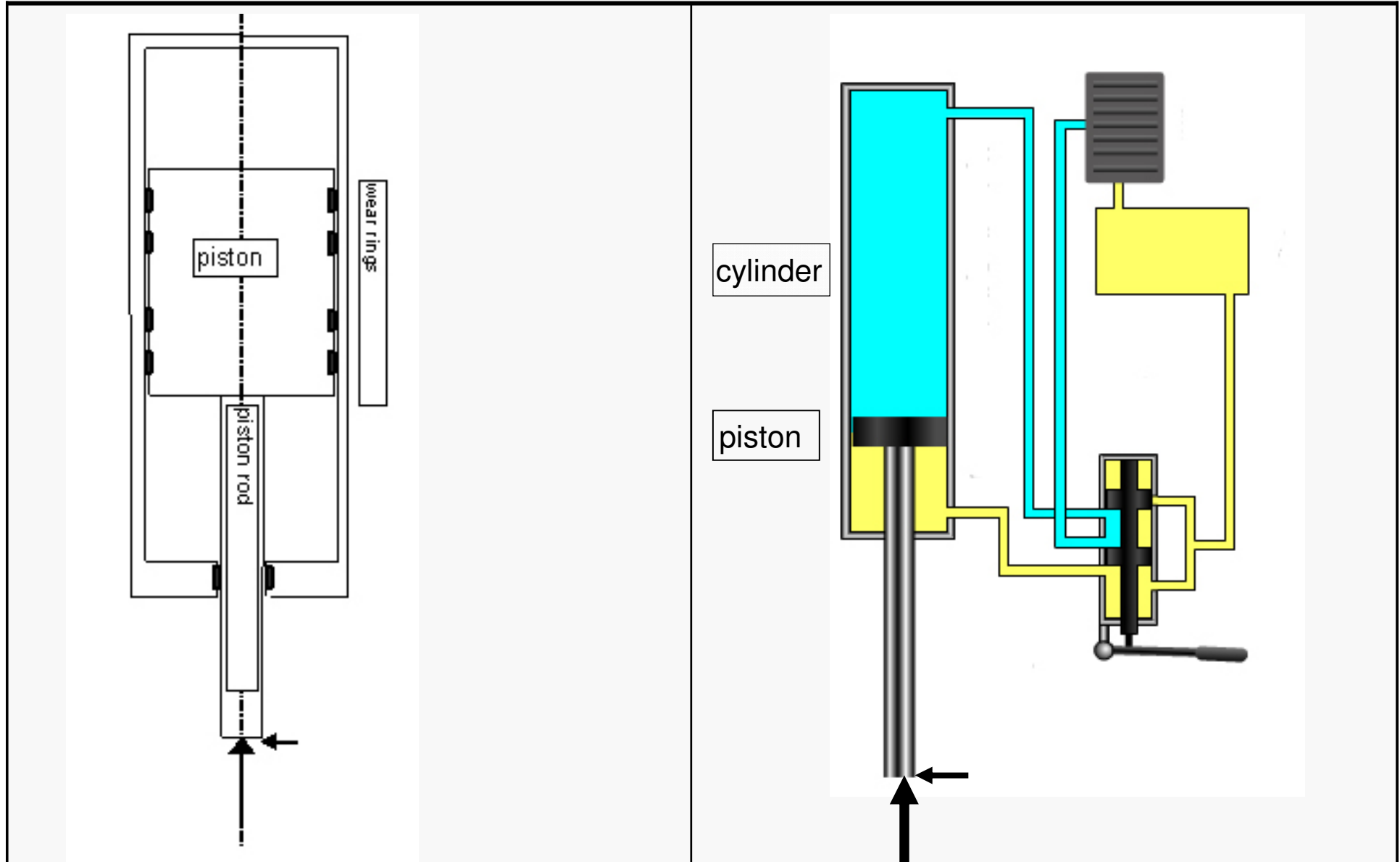

radial clearance

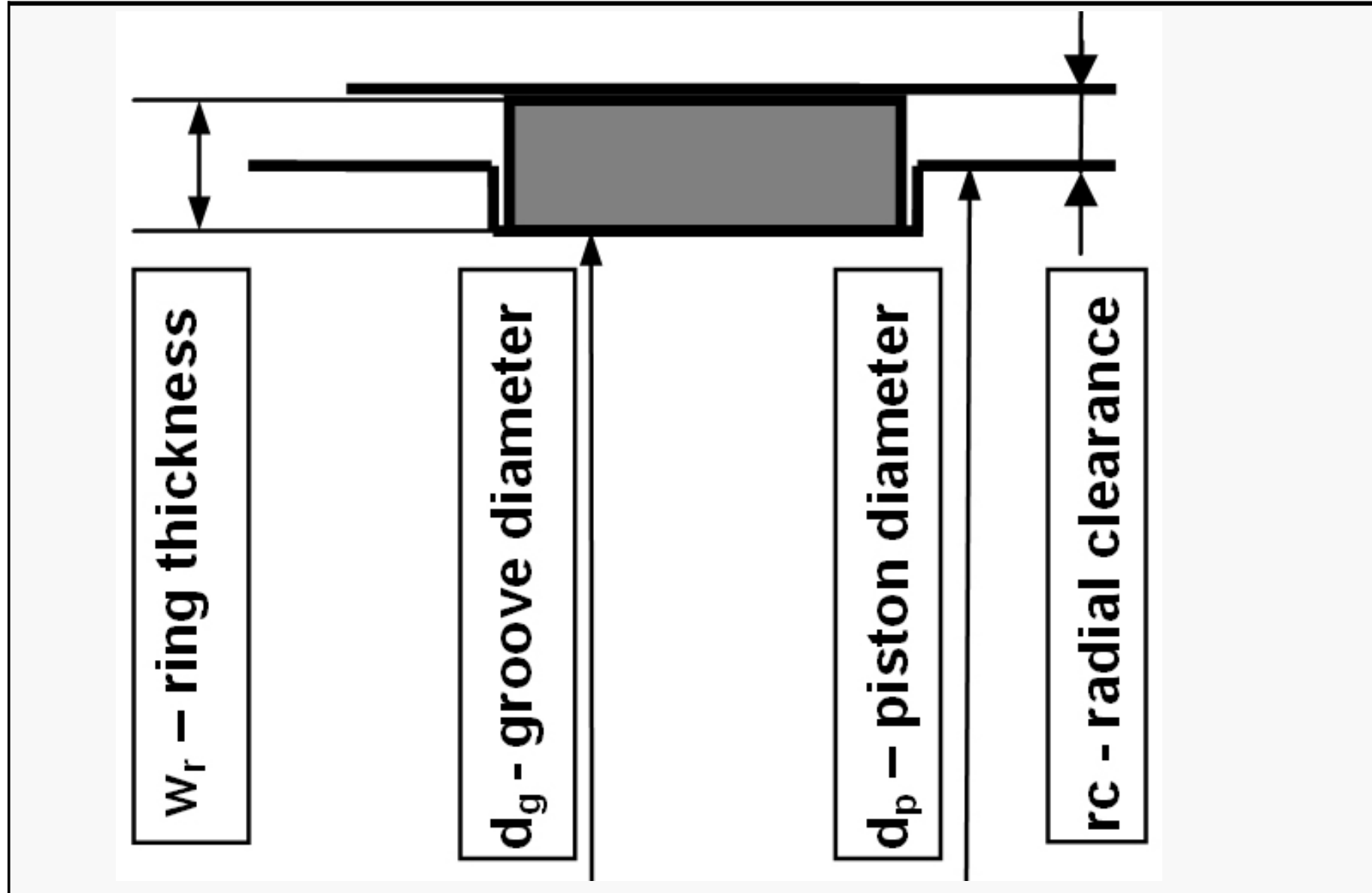

Court Case history

- Court cases about technical cases last very long.
- In The Netherlands we have party expert witnesses
- **Court appoints expert witnesses.**
- Court poses a number of questions.
- **Expert witnesses investigate and write Concept report**
- Party expert witnesses comment the concept report.
- **Expert witnesses write the final report.**
- The judge comes to a verdict.
- The loosing party finds a party expert witness to reopen the case.
- Expert witnesses re-investigate the case.

Spormaker Consultancy in Reliability & Liability of Plastic Products

Dossier



The Court Case

For a large crane installation hydraulic cylinders were designed to level the crane on the soil. This was expected to happen only once and minimal clearance between the cylinder and the piston was used. The stiffness values from the brochure to select the **wear rings** had been applied.

The clearances were too low and metallic contact occurred. The manufacturer of the rings was blamed, because the design information in the brochure was incorrect. The **stiffness of the wear rings was lower** than indicated in the brochure.

wear rings in piston

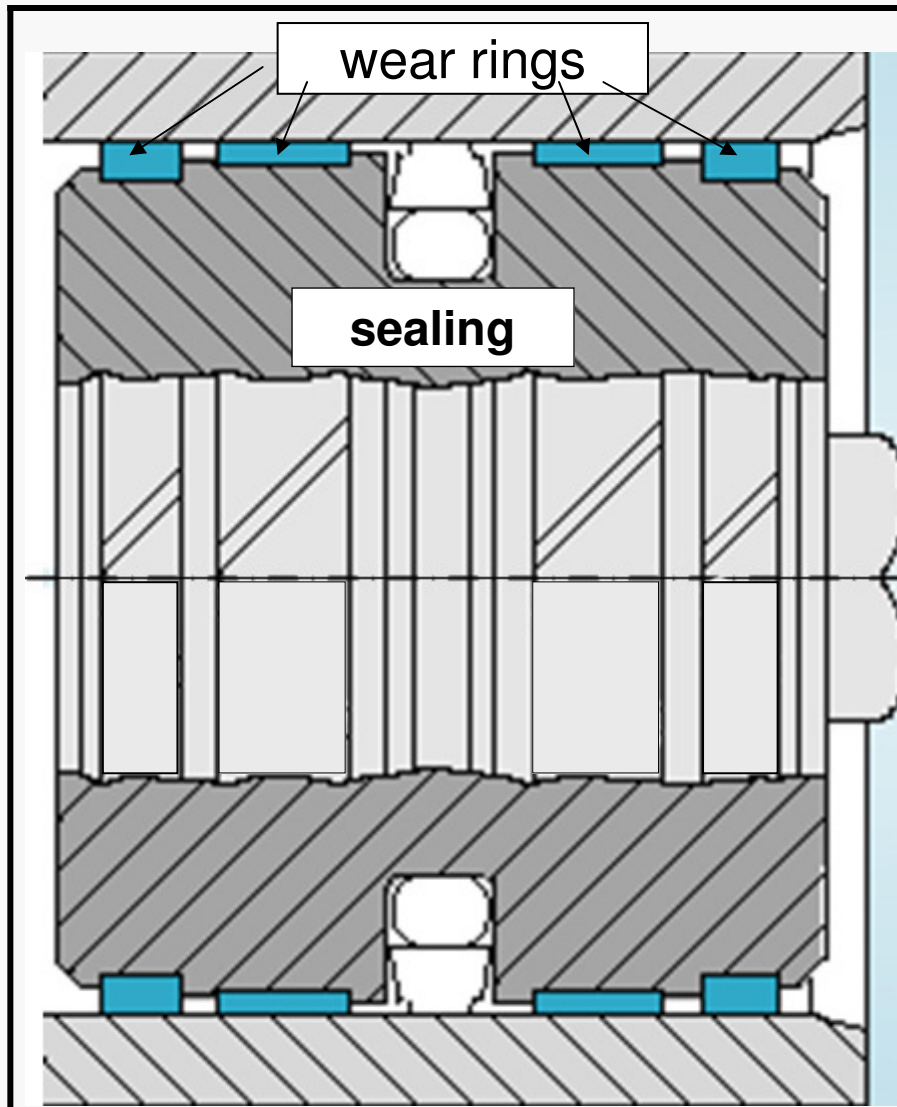

Wear rings are required to be stiff enough to avoid metallic contact between piston and cylinder

Metallic contact resulted in a damage of some:
\$ 350 000

Contact stresses more accurate

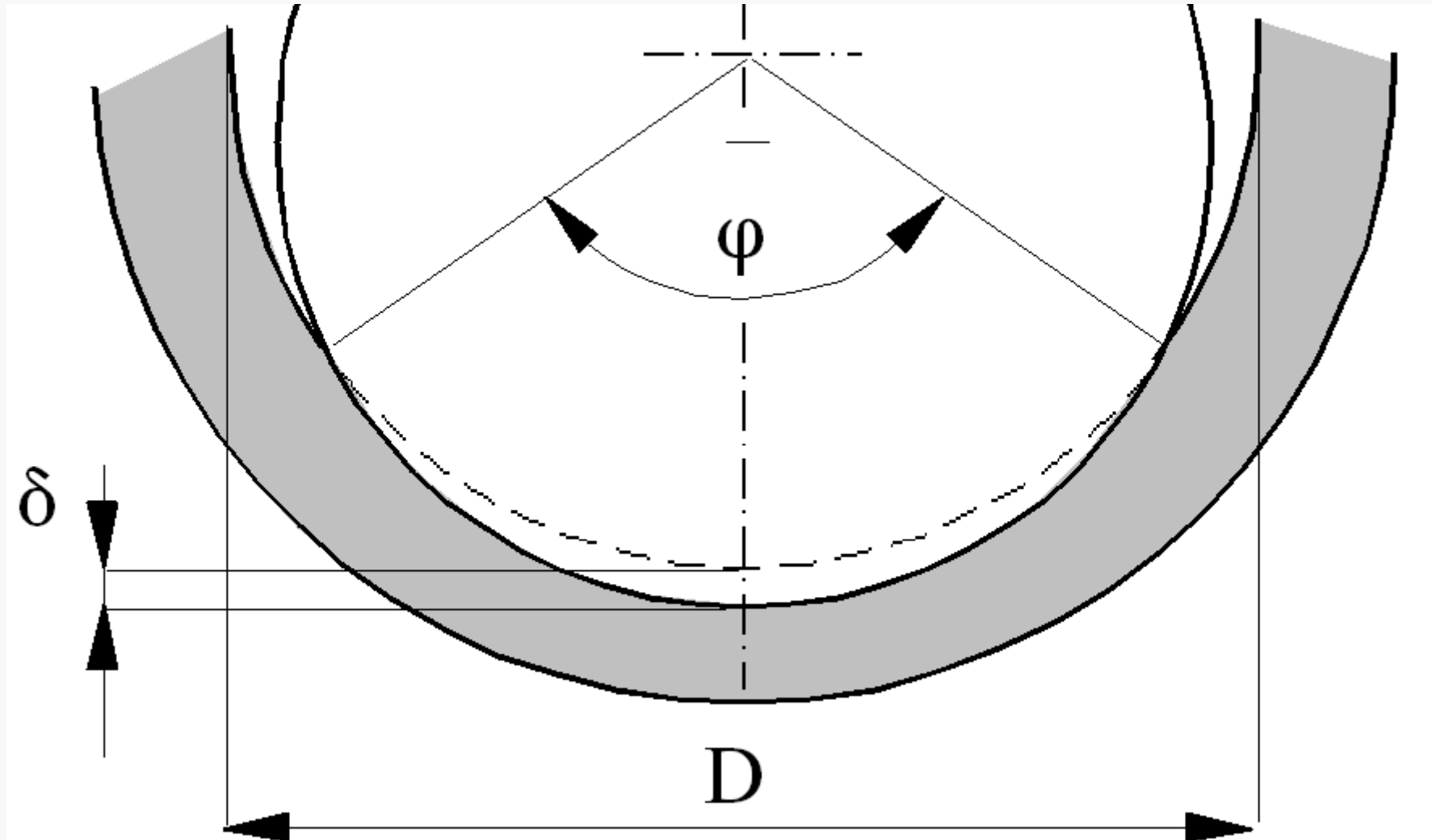

average bearing pressure

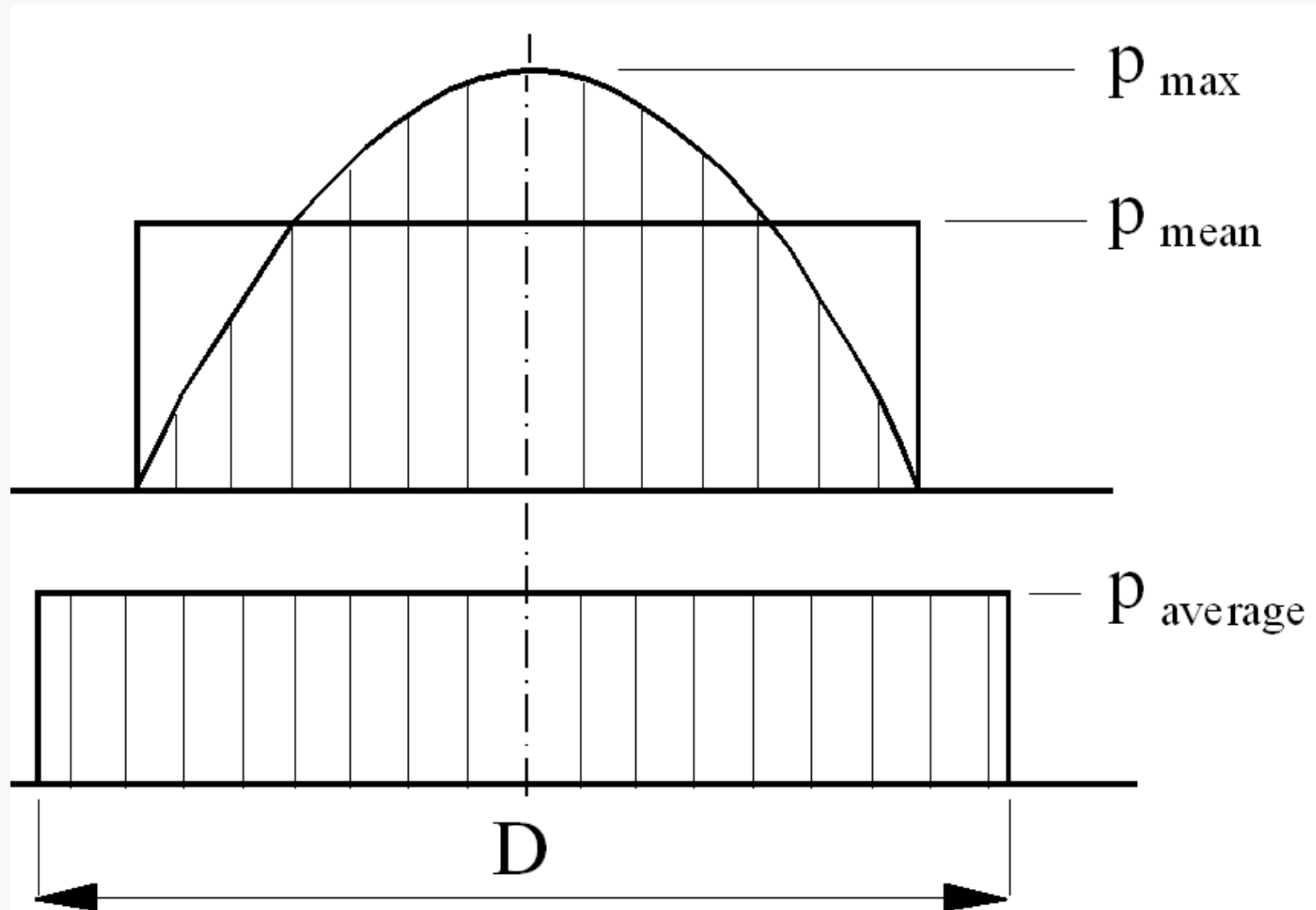

Calculation of average bearing pressure

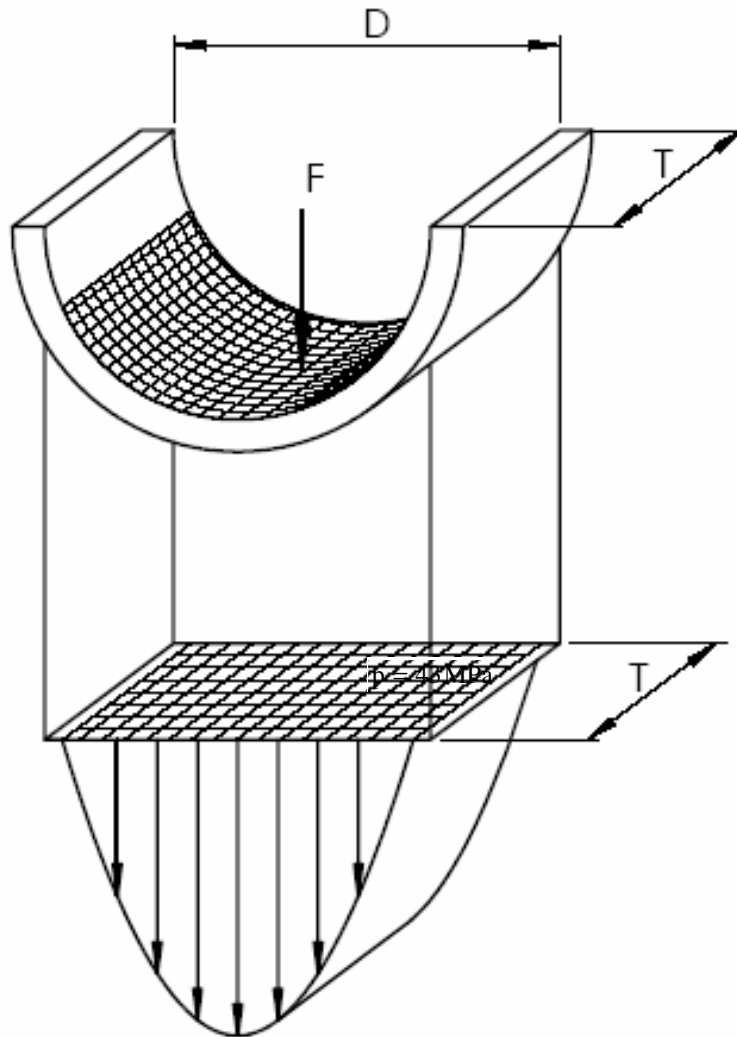

$$p_{abp} = \frac{F_r}{n \times w_r \times d_g}$$

$$p_{abp} = 21.5 \text{ N/mm}^2$$

$$p := 2 \cdot p_{abp}$$

$$p = 43 \text{ MPa}$$

Calculation of worst case radial clearance

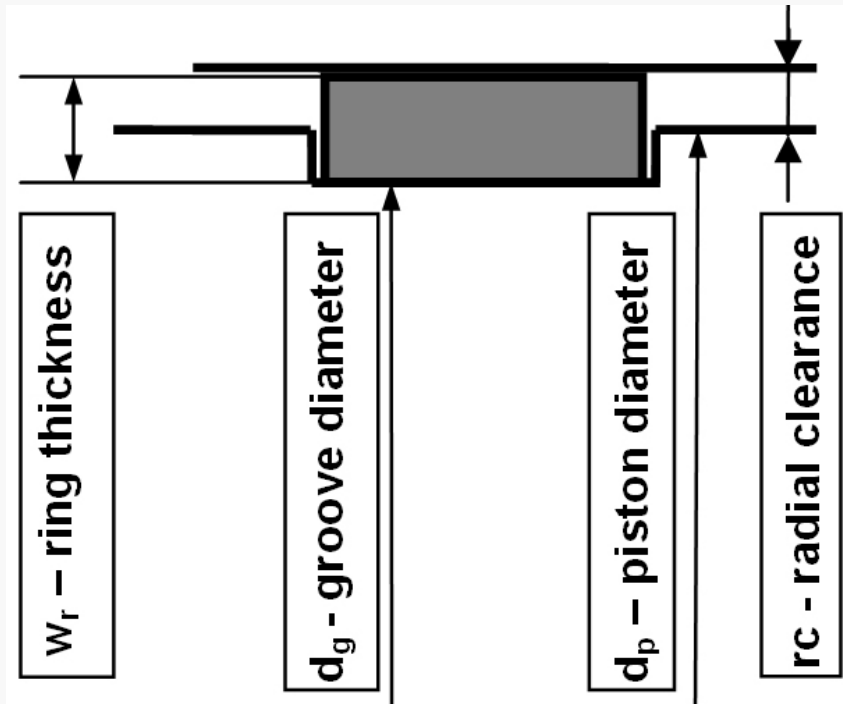

maximum piston diameter	$dp_{\max} = 359.5 \text{ mm}$
minimum groove diameter	$dg_{\min} = 354.9 \text{ mm}$
minimum ring thickness	$wr_{\min} = 2.42 \text{ mm}$

$$rc = \frac{dg_{\min}}{2} + wr_{\min} - \frac{dp_{\max}}{2} = 0.12 \text{ mm}$$

Stress-displacement from the brochure

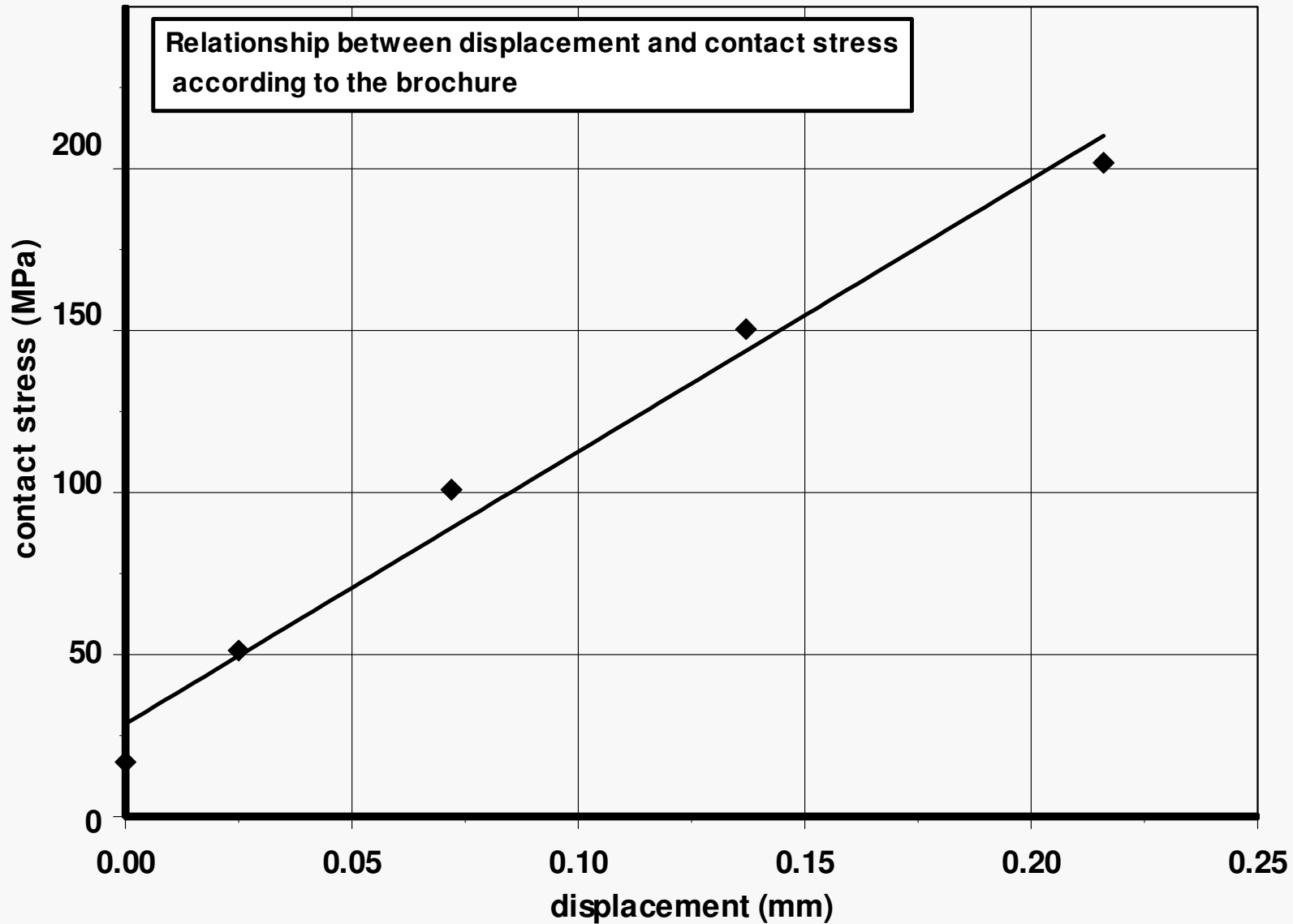

Spoomaker Consultancy in Reliability & Liability of Plastic Products

Compression as a function of average bearing pressure

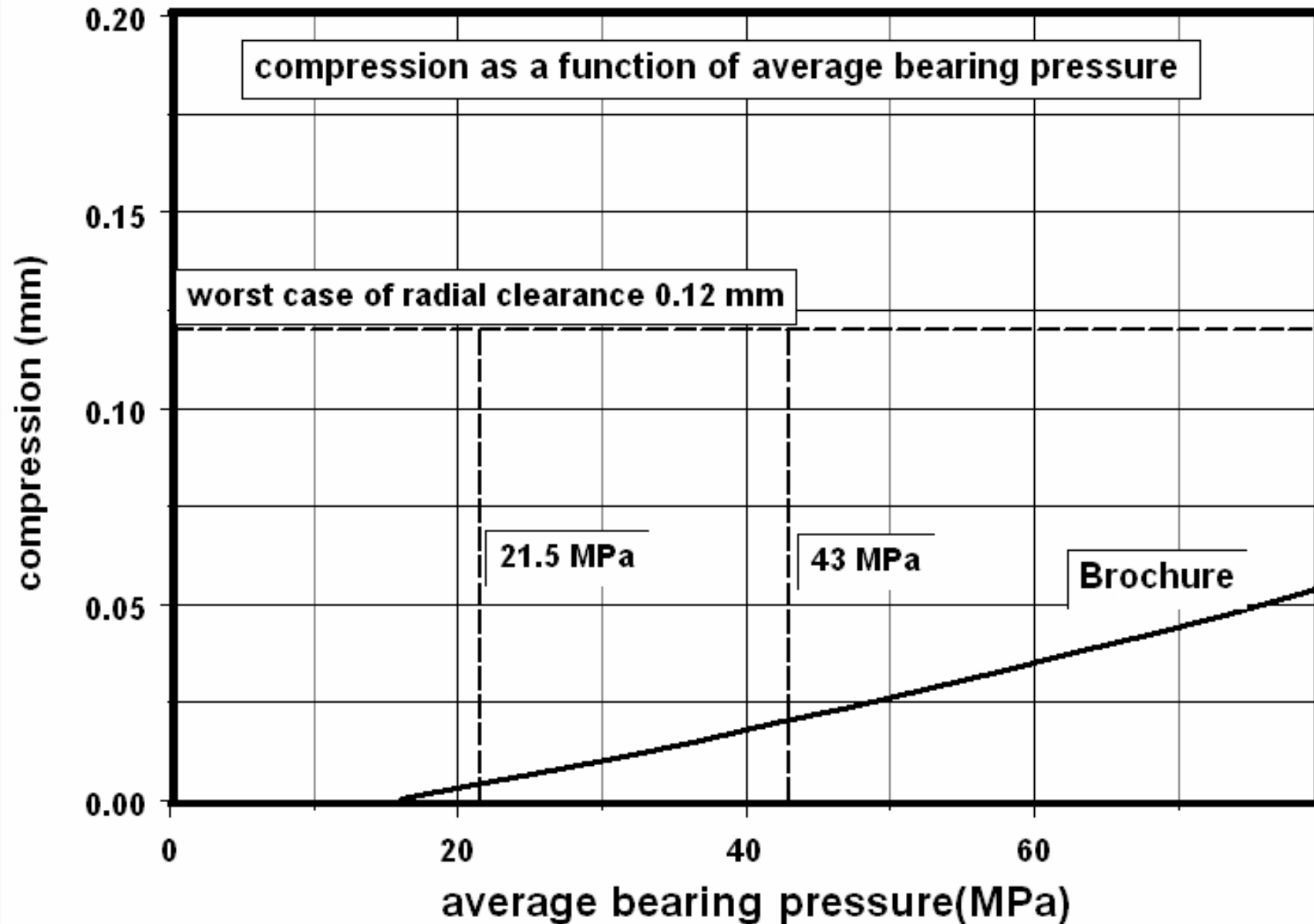

Drawing of experimental set-up

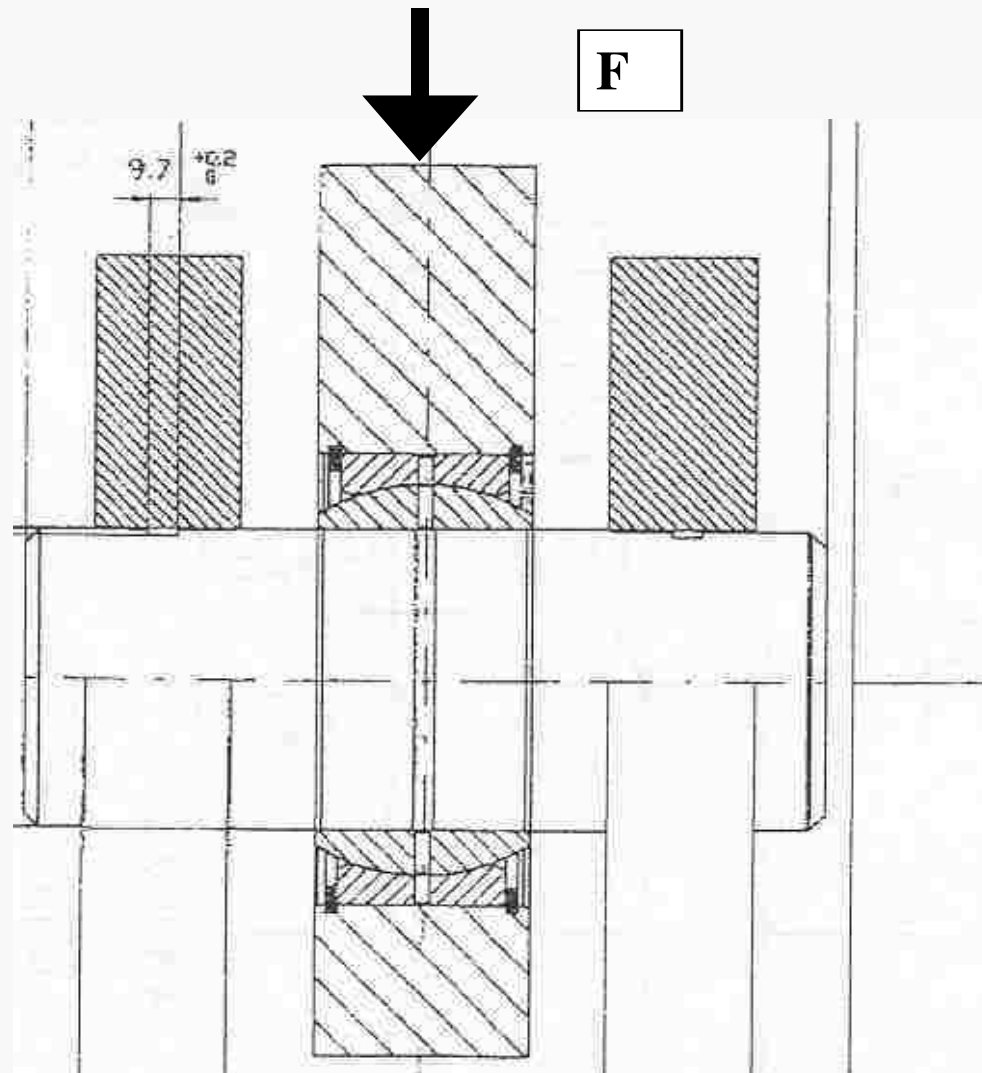

Photograph of the experimental set-up

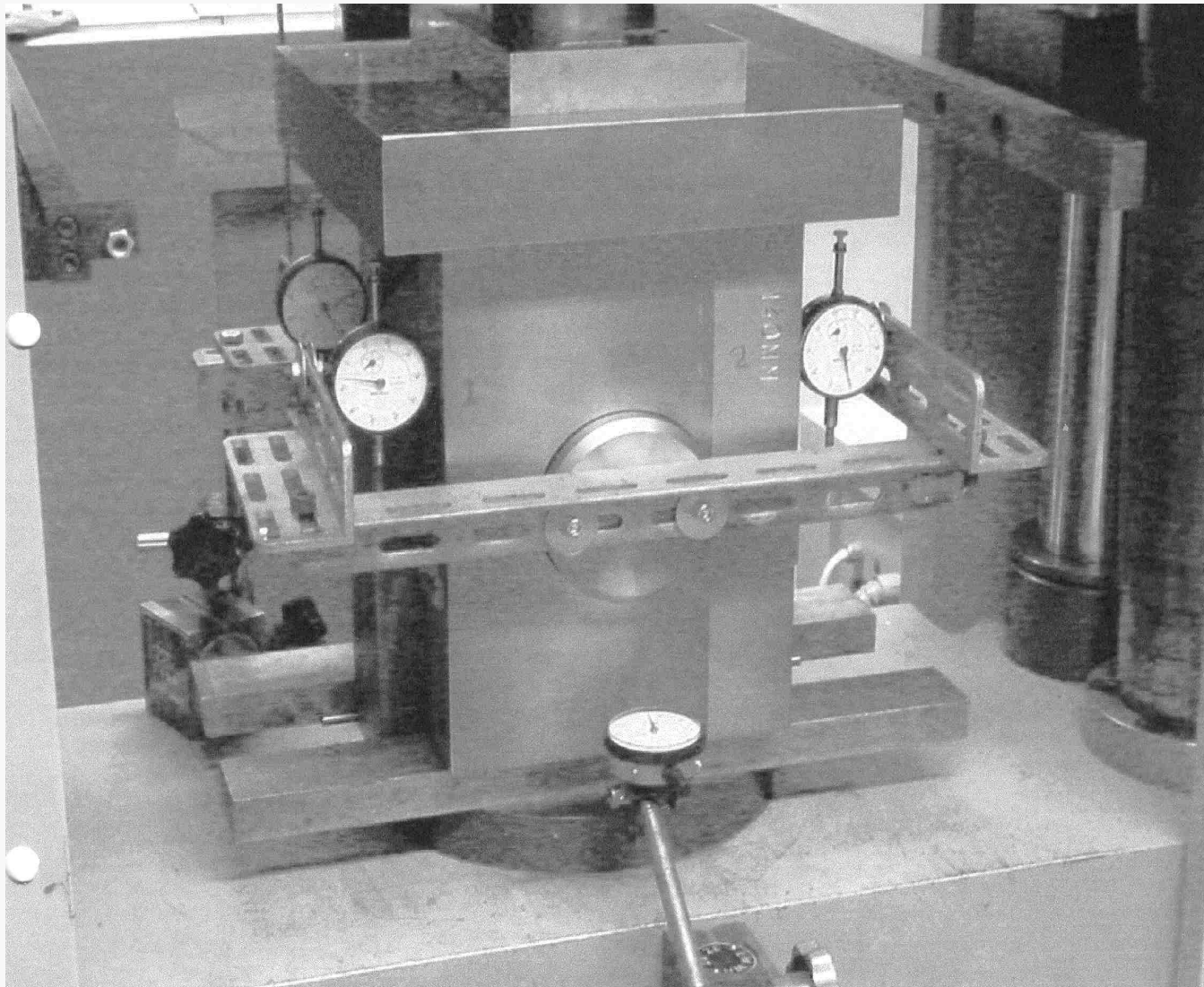

Compression curve measured at Delft University of Technology

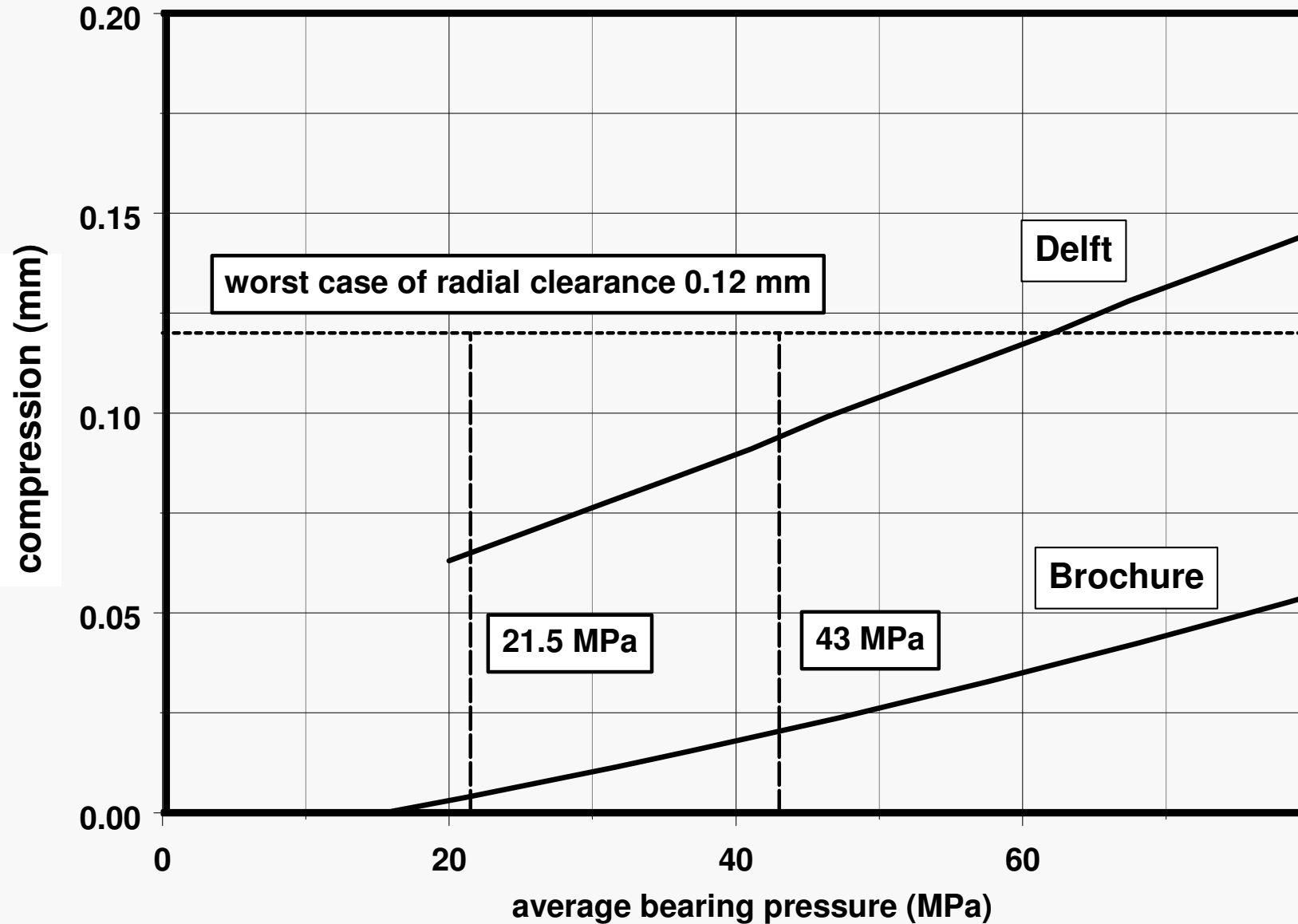

End of first act

- The stiffness of the wear rings is considerably lower than the values in the brochure.
- Metallic contact can not be explained from the new measurements.
- The transversal force might be too high.

Begin of second act

New party expert witness stated:

- The experiments in Delft have been carried out after full loading on the wear ring to eliminate setting effects.
- Plastic deformation has occurred and should be accounted for by adding 0.04 mm to the “Delft” curve.
- For the worst case of radial clearance metallic contact is likely.

Expert witnesses stated:

- Plastic deformation might have occurred and the “Delft” curve could be shifted by 0.04 mm.
- Worst case of radial clearance is very unlikely.
- Probabilistic approach.

Use of Normal Distribution

mean

$$\mu_{rc} = \frac{\mu_{dg}}{2} + \mu_{wr} - \frac{\mu_{dp}}{2} = 0.21 \text{ mm}$$

standard deviation

$$\sigma_{rc} = \sqrt{\left(\frac{\sigma_{dg}}{2}\right)^2 + (\sigma_{wr})^2 + \left(\frac{\sigma_{dp}}{2}\right)^2} = 0.0178 \text{ mm}$$

The 1 % percentile of the radial clearance

$$rc_{1\%} = \mu_{rc} - 2.33 \times \sigma_{rc} = 0.21 - 2.33 \times 0.0178 = 0.168 \text{ mm}$$

Influence of plastic deformation

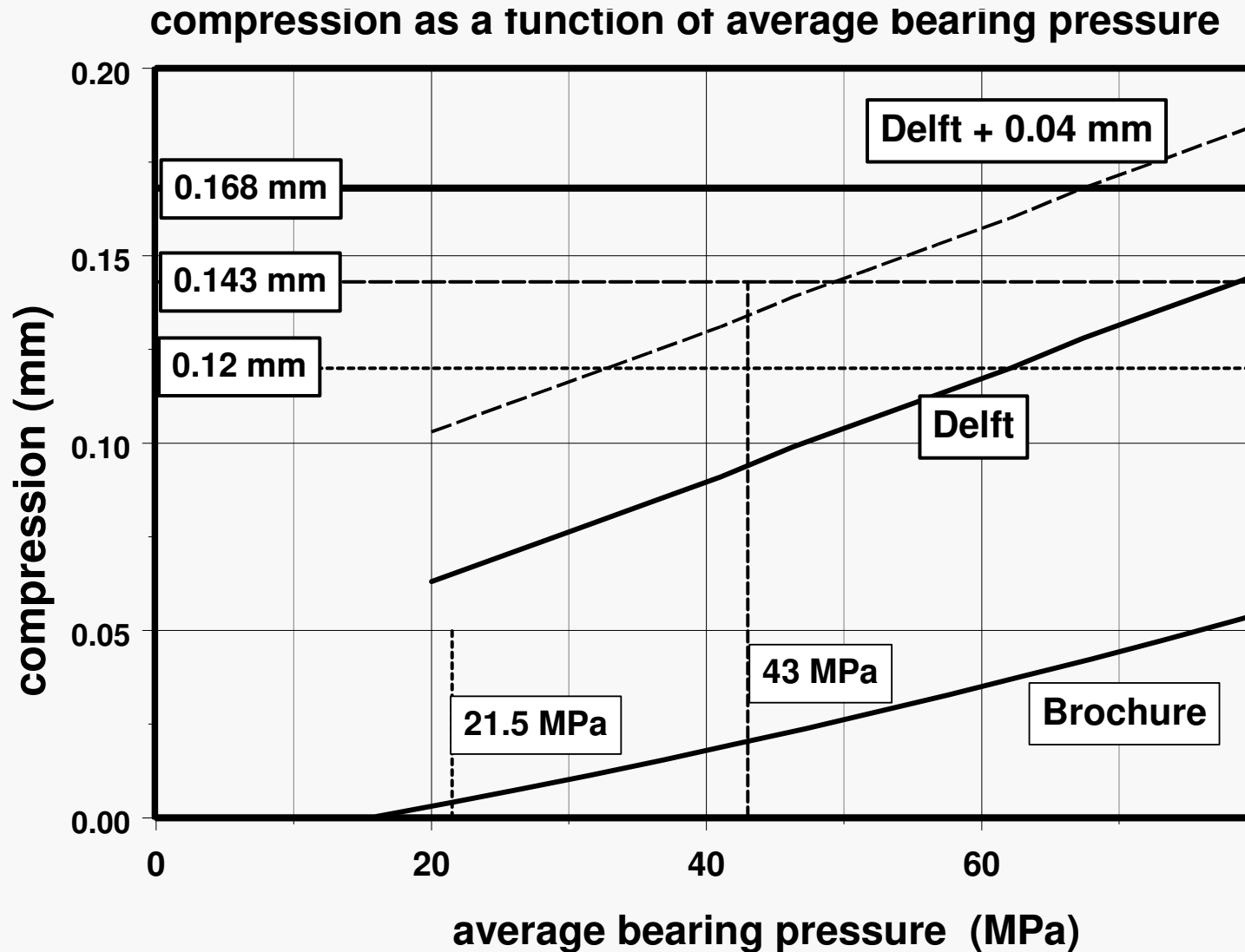

Spoomaker Consultancy in Reliability & Liability of Plastic Products

Monte Carlo simulation of radial clearance for uniform distributions

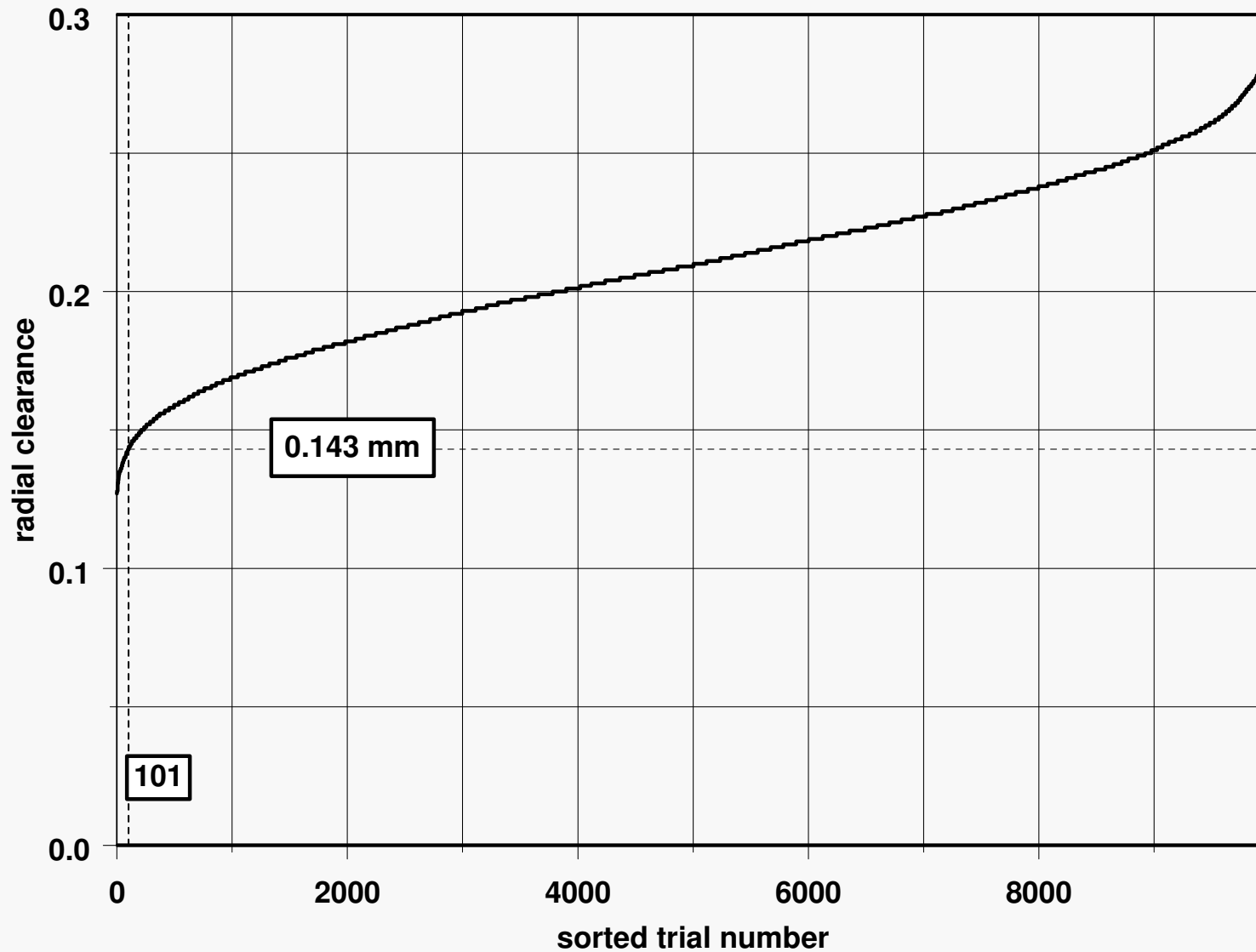

Distributions of dimensions of strip

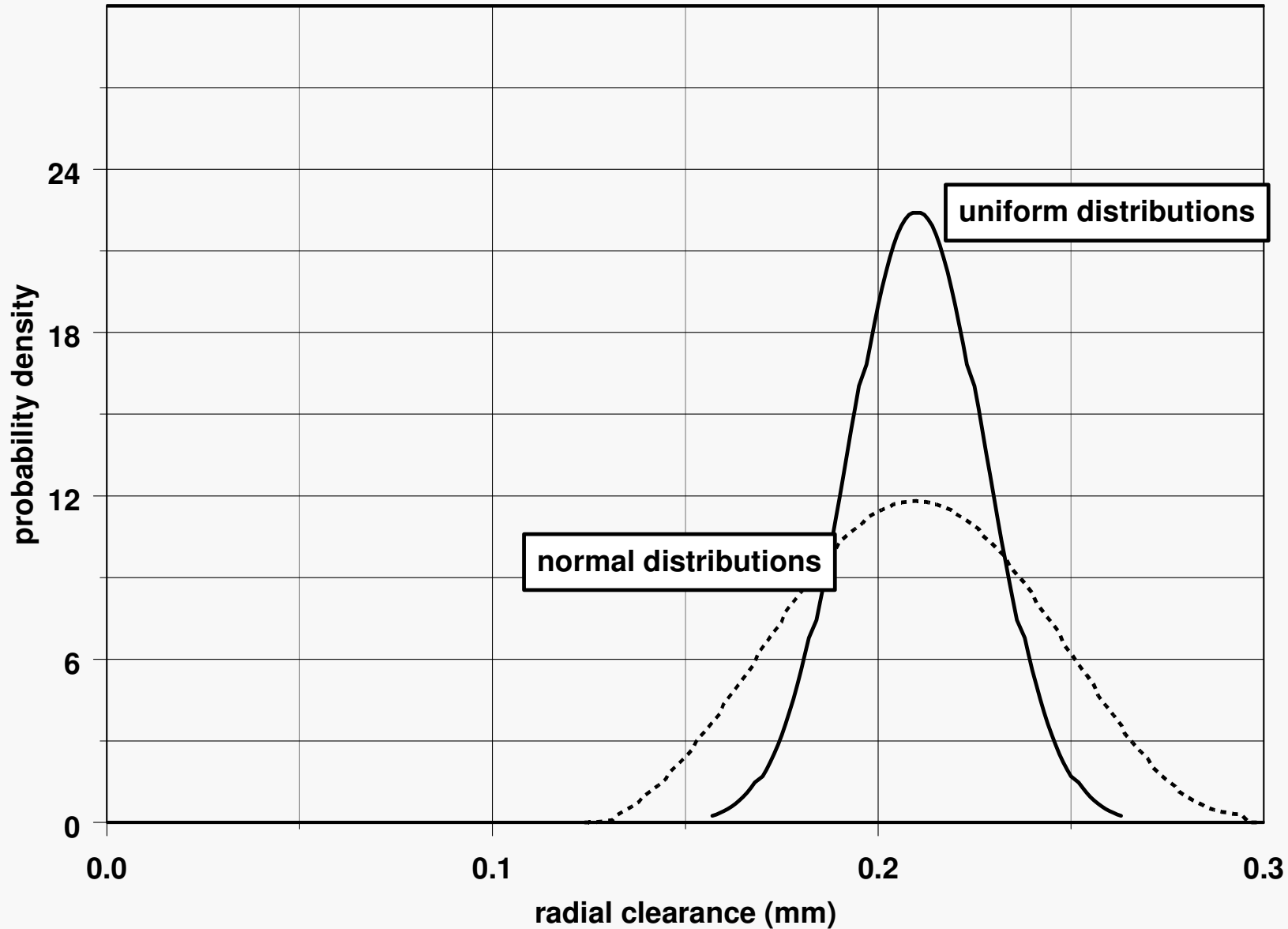

Use of Uniform Distributions

The 1 % percentile of the radial clearance is 0.143 mm

Taking a safety factor of 2 implies that:

99 % of the average bearing pressure is below 43 Mpa

The probability of failure is < 0.0001

Influence of plastic deformation

compression as a function of average bearing pressure

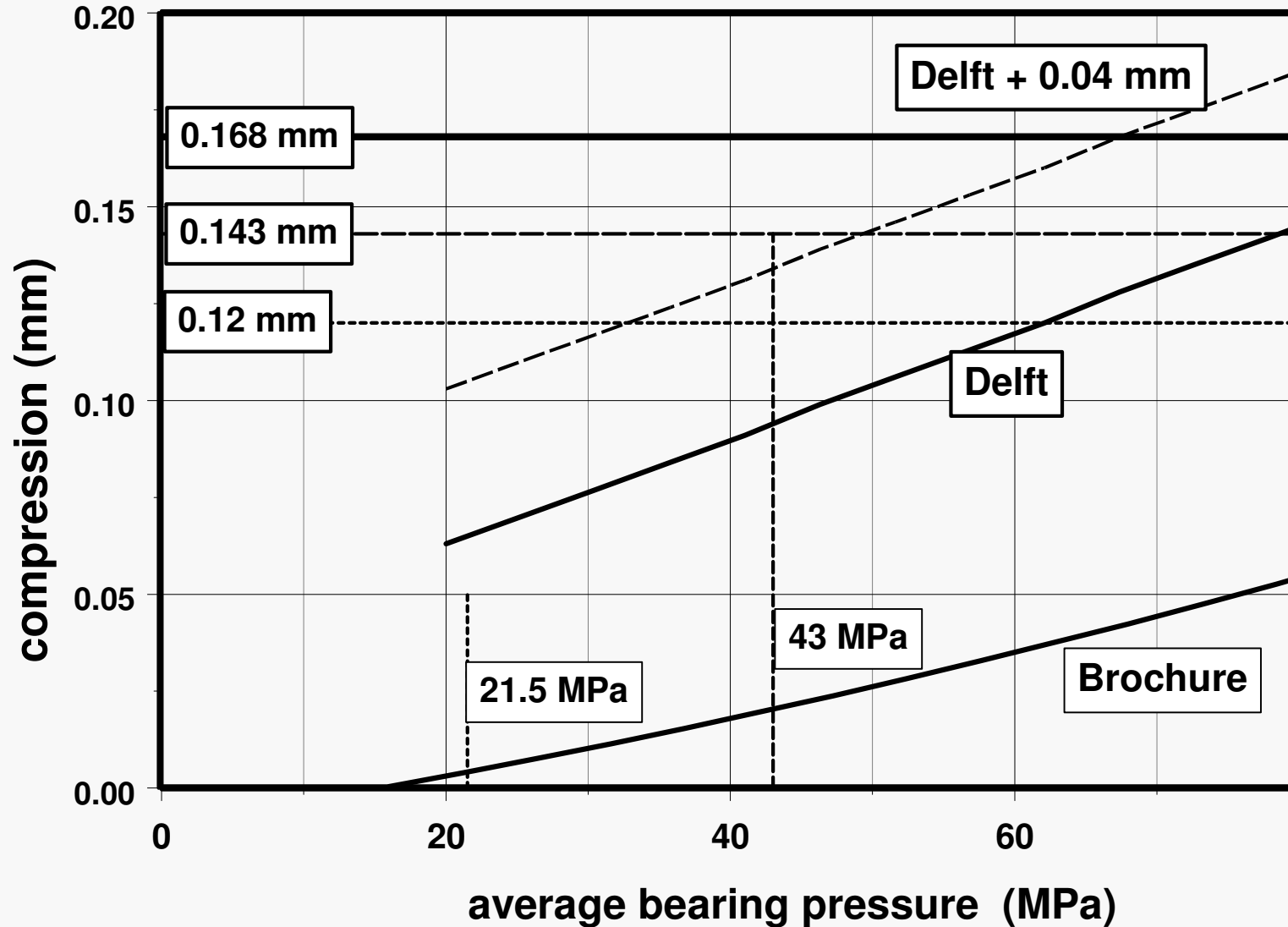

Influence of plastic deformation

- Metallic contact

Finite Element Method mesh

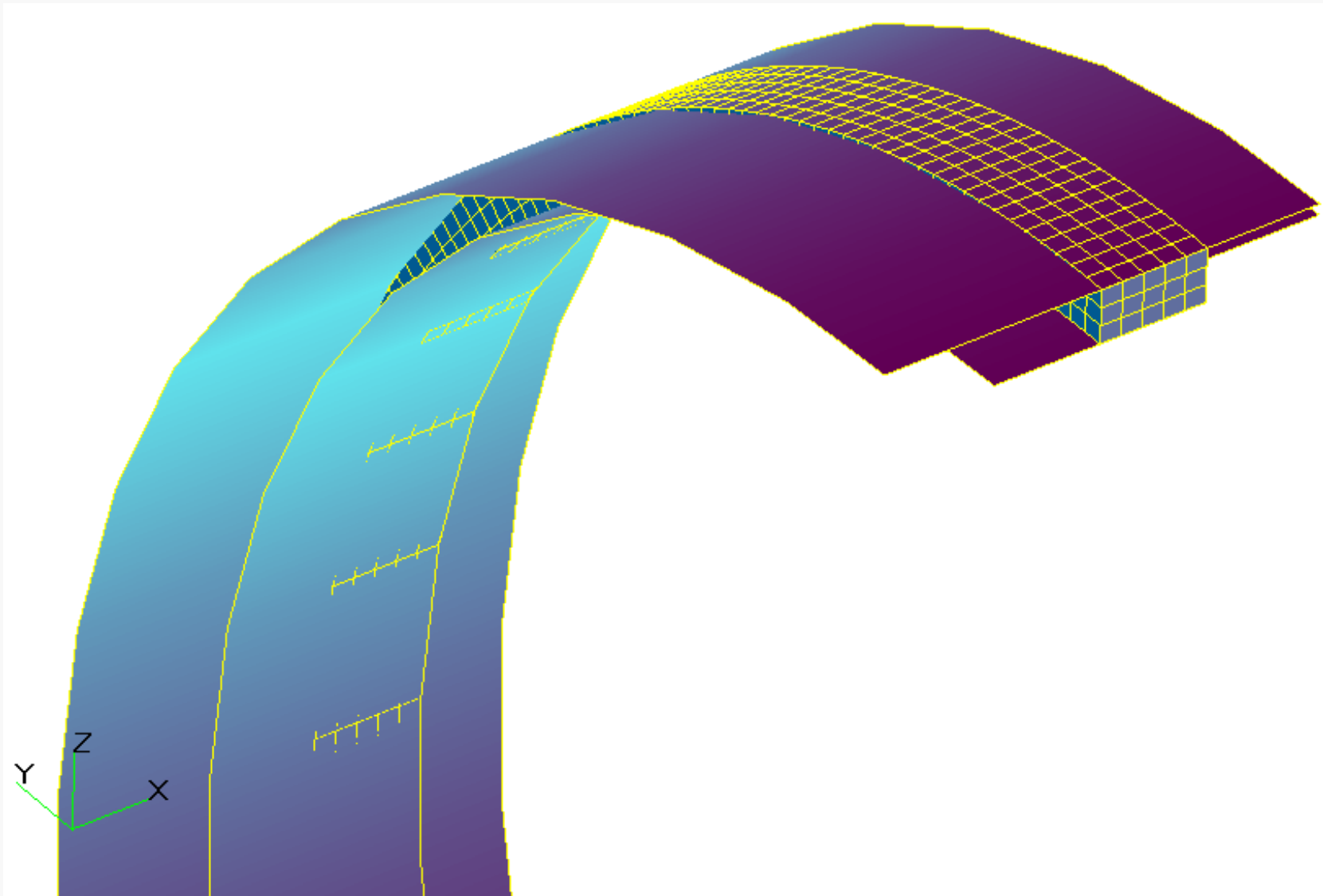

Finite Element Method calculation results

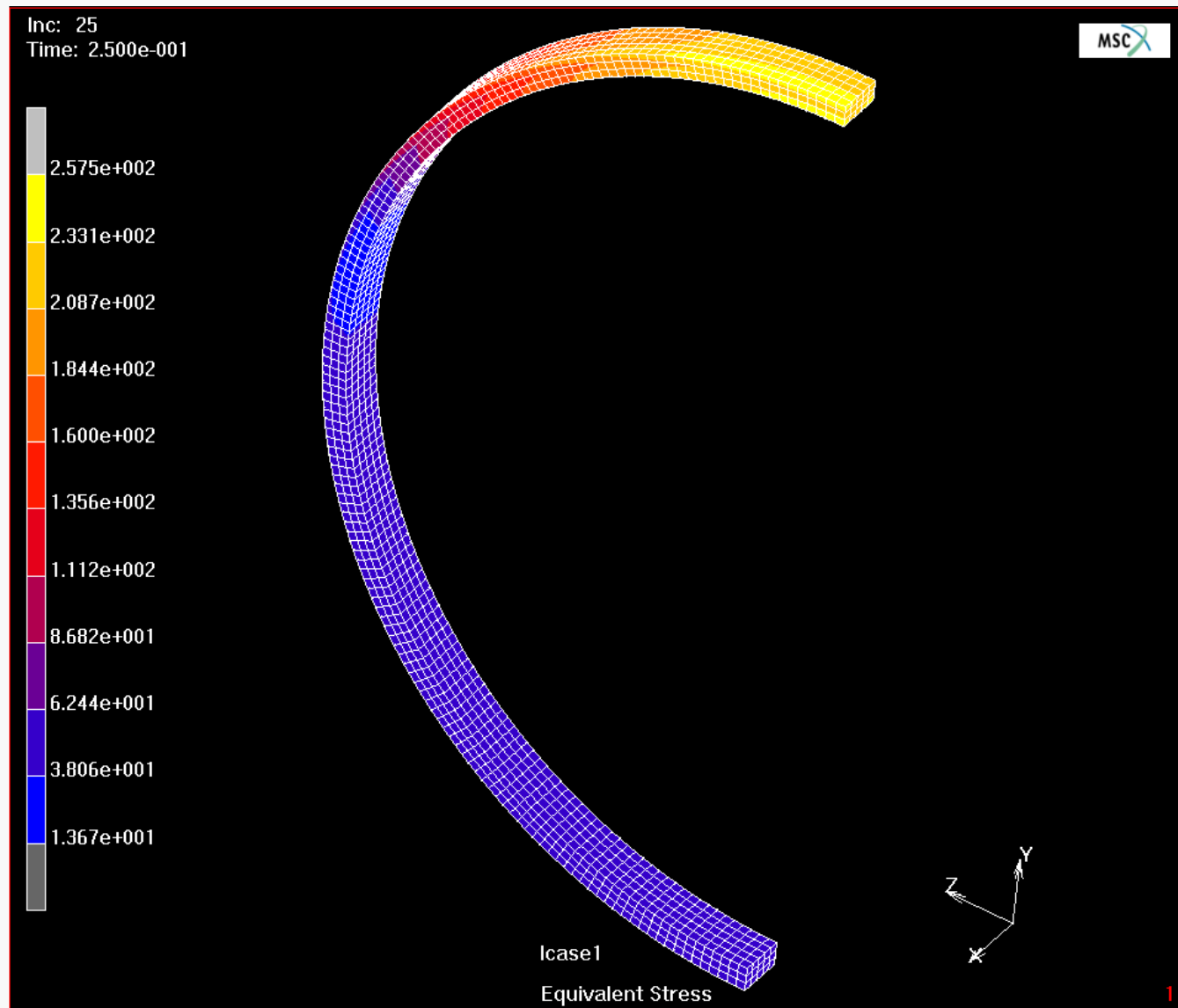

Deformational behavior of strip

Dimension of the specimen

Length:	49.5 mm
Width	9.45 mm
Thickness	2.47 mm (before loading)
Thickness:	2.40 mm (after loading)